

# Complete valve solutions for the pulp and paper industries

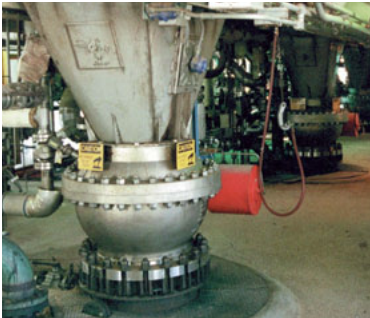

- Knife gate valves
- Metal-seated ball valves
- Resilient-seated ball valves
- Gate, globe, and check valves
- Torqseal™ triple-offset valves
- Cap-Tight digester capping valves

Sizes: 1/4 – 64" (8–1600 mm)



# VELAN

# A world leader in valve design, engineering solutions, and manufacturing



A large Torqseal™ triple-offset valve used for crude oil service in the Dalian Seaport (China).

## Leading the way...

Velan is one of the world's largest manufacturers of industrial steel valves, recognized as a leader in quality and innovation. Founded by A.K. Velan in 1950, our company leverages advanced engineering capabilities and innovation to continuously expand our offering of industrial valves.

Today, Velan gate, globe, check, ball, triple-offset, knife gate, and engineered severe service valves are installed throughout the world, handling diverse applications in cogeneration, fossil, nuclear power, oil and gas, refining and petrochemicals, chemicals and pharmaceutical, pulp and paper, LNG and cryogenics, marine, mining, water and wastewater, and HVAC industries.

## Engineered solutions

Velan's Engineering Group has vast experience, sophisticated software, and testing tools that enable us to find solutions to any customer challenge.

Whether it is for valves to handle liquid helium at  $-458^{\circ}\text{F}$  ( $-272^{\circ}\text{C}$ ) in the world's largest particle accelerator at CERN, Geneva; four-way switch coker ball valves to handle one of the refining industry's toughest services; or valves for main steam isolation service in an operating nuclear power plant, Velan has been selected by most of the world's leading engineering construction firms and industrial end users. A long-standing commitment to quality has kept Velan at the forefront of industry standards.

Velan holds all major industry certifications, including ASME Section III, ISO 9001:2000, PED, and API 6D. Many prominent companies have established partnerships or global supply agreements with Velan.

## A global manufacturing leader

Velan uses the latest automation technology, including CNC machines and many special-purpose transfer machines, enhanced by proprietary production techniques. Thanks to a wide range of equipment, we can efficiently handle highly customized orders as well as large production runs.

Velan employs over 1,800 professionals, the majority of whom are located in North America. International production centers are complemented by a global sales and distribution network, offering personal customer service and quick access to stock worldwide. Because customer requirements for immediate deliveries have escalated in the last few years, Velan has opened a number of VelNow quick-ship warehouses in North America to supplement the inventories of our stocking distributors.

## Total quality commitment

Velan is totally committed to offering products and services that exceed customer expectations. All Velan valves are designed and manufactured with an emphasis on low emissions, safety, simple maintenance, ease of operation, and, above all, long, and reliable service life. In fact, several years ago when a leading North American repair shop did an analysis on the reliability and reparability of commodity valves, Velan finished first. Whether we are manufacturing commodity valves or specialty valves, we deliver excellent long-term value to our customers.

## VELAN AT A GLANCE

### History

- Founded in 1950

### Sales

- Over \$400 million

### People

- Over 1,800 employees

### Global network

- 13 production facilities
- 5 plants in North America
- 4 plants in Europe
- 4 plants in Asia
- 4 stocking and distribution centers
- Hundreds of distributors worldwide
- Service shops worldwide

### Product line

A world-leading range of cast and forged steel gate, globe, check, ball, triple-offset, knife gate, severe service valves and steam traps across all major industrial applications

### Quality

- All major approvals
- ISO 9001 (since 1991)
- ASME N stamp for nuclear quality (since 1970)
- API 6D
- Total Process Improvement Program including Lean Manufacturing, Six Sigma

### Engineering

Leader in valve design with many first-to-market innovations:

- Extensive engineering, R&D, cycle test facilities, and stress analysis
- Proven ability to satisfy special project requirements
- Field Engineering Services

### Production capabilities

Leader in automated production:

- CNC and multi-station transfer machines

### Velan value

- Strong management team, stable company

Products proven to offer:

- Low emissions
- Easy maintenance
- Long and reliable service
- Low TCO
- Quality that lasts



# Serving the industrial world's toughest applications

Velan has an installed base in most major pulp and paper mills throughout North America and the world. Although Velan is a relative newcomer to the pulp and paper industry, concentrating on becoming a market leader in the power industry, the Velan product line fits pulp and paper like a hand in a glove.

We offer a complete line of forged and cast steel gate, globe, check, ball (resilient and metal-seated), triple-offset, and knife gate valves. Velan manufactures valves in sizes up to 64" (1600 mm), designed specifically for reliable, low fugitive emissions in difficult services in pulp and paper mill applications.

Velan valves represent over fifty years of evolutionary improvements that have helped us perfect our designs. Central to Velan's pulp and paper valve technology is our Securaseal® product line of rugged metal-seated valves offering greater strength and longer service life. Another key feature of Velan valves is our emphasis on simple maintenance; for example, our Memoryseal™ top-entry ball valves feature in-line replaceable seats.

Velan gate, globe, and check valves are available with forged steel bodies in sizes up to 24" (600 mm) and cast steel bodies



A filter isolation installation of Velan knife gate valves.

up to 64" (1600 mm), with or without motor actuators. Furthermore, Velan offers a variety of engineered valves for special services in pulp and paper mills, including Cap-Tight our metal-seated capping ball valve and bolted bonnet knife gate valves for black liquor service. Velan's vast offering of valves is well positioned for high performance in virtually every pulp and paper application.

## Velan's pulp and paper product line

### Gate valves

¼–64" (8–1600 mm), ASME classes 150–4500  
Catalogs: VEL-PS, VEL-SFV, VEL-CSV



### Globe valves

¼–24" (8–600 mm), ASME classes 150–4500  
Catalogs: VEL-PS, VEL-SFV, VEL-CSV



### Check valves

¼–36" (8–900 mm), ASME classes 150–2500  
Catalogs: VEL-PS, VEL-SFV, VEL-CSV, VEL-DPCV



### Knife gate valves

2–36" (50–900 mm), ASME classes up to 150 psig  
Catalogs: VEL-KGV



### Metal-and resilient-seated ball valves

¼–24" (8–600 mm), ASME classes 150–4500  
Catalogs: VEL-BV, VEL-MS, VEL-PBV, VEL-TE, VEL-GPBV



### Cap-Tight capping valves

up to 24 x 36" (600 x 900 mm)  
Catalogs: VEL-BDC



### Torqseal™ triple-offset valves

3–48" (80–1200 mm), ASME classes 150–600  
Catalogs: VEL-BF



### Proquip dual-plate check valves

2–60" (50–1500 mm), ASME classes 150–2500  
Catalogs: VEL-DPCV



### Steam traps

0–2600 psi (179 bar), 1,100°F (593°C)  
Catalogs: VEL-ST



With 1,242,500 sq. ft. (108,300 m<sup>2</sup>) of production space in thirteen specialized manufacturing plants, Velan is a true global manufacturing force.



One of Velan's thirteen production centers, this plant in Montreal, Canada houses 170,000 sq.ft. of production space devoted to manufacturing Velan's most sophisticated valves—including Velan's Cap-Tight capping valves.

# Successful application solutions

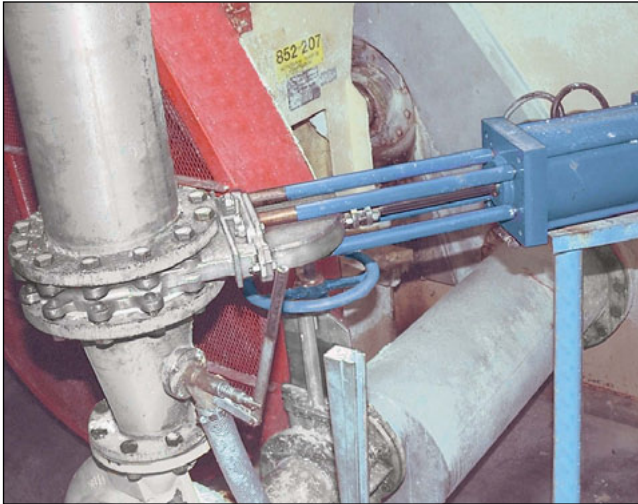

*Pump discharge shut off —5% pulp at 70 psi (4.8 bar) cycling over 75 times a day.*

## Application expertise: Knife gate valves

### Application

Pump discharge isolation

- 50–130 psi (3.5–9 bar)  
—from the pump up to 50 psi (3.5 bar)—header.

### Media

Fresh water, white water (1%) clear pulp up to 5%:

- Valves are normally actuated and cycle many times a day.
- Bi-directional shutoff required.

### Problem

Standard knife gate valves not designed for bi-directional shutoff.

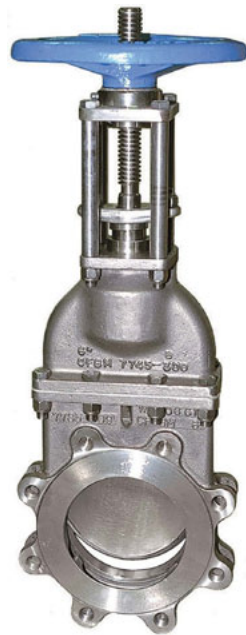

### SOLUTION: Velan's bolted bonnet knife gate valve

- All stainless steel construction.
- Seat tightness achieved with torque as opposed to line pressure:
  - bi-directional shutoff
  - zero to 150 psi.
- Conventional packing chamber eliminates leakage problems associated with standard knife gates.

## Application expertise: Ball valves

### Application

Batch digester blow valve:

- Empty contents of digester into blow tank.

### Media

Stock (chips), liquor, tramp metal (bullets, barb wire, carburetors, etc.):

- Valves are actuated and cycle many times a day.
- Valves cycled slowly to alleviate blow line shock.
- Velocities through the valve are high.

### Problem

Valves leak internally and externally.

### SOLUTION:

#### Velan's Securaseal® metal-seated ball valve

- All stainless construction.
- Seat tightness achieved with torque as opposed to line pressure – bi-directional shutoff.
- Uninterrupted, fully retained on four sides, body gasket.
- Solid tunnel bore ball.
- Locked seats to stop migration of stock behind the seats.
- Reliable cup andcone packing design to alleviate external leakage.

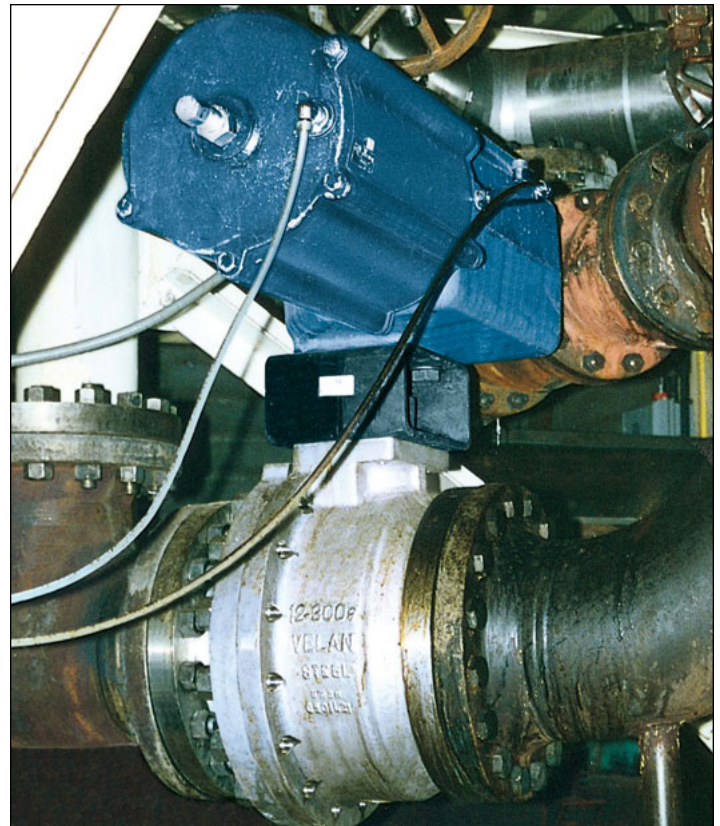

*Velan Securaseal® metal-seated digester blow valve in service at a pulp mill.*



# Successful application solutions

## Application expertise: Ball valves

### Application

Continuous digester heater isolation valves:

- Isolate the heaters from the digester and each other.

### Media

Black liquor:

- Scaling of cooking liquors.
- Valves are normally manual with gear actuators.

### Problem

Valves stick, leak internally and externally.

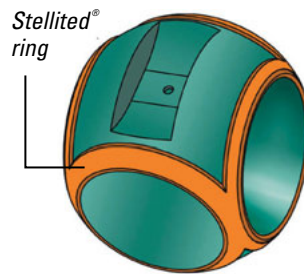

*The use of a Stellited® ring (orange) eliminates the need for either hard chrome plating or electroless nickel and is compatible with most acids used to de-scale heaters.*



*Torqseal™ triple-offset valve application.*

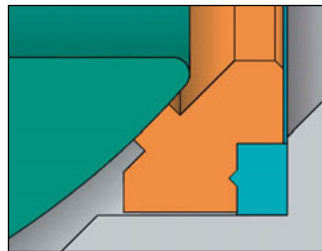

*The solids-proof scraper seat with bi-directional shutoff ensures smooth operation in processes that have a high solids content. The graphite is acting as a seal and spring ensuring that the valve has the capability to shutoff at low pressure.*

### SOLUTION:

**Velan's Securaseal® metal-seated ball valve with ring ball**

- Uninterrupted, fully retained body gasket.
- Low torque ball—weld overlay on the seating surface means no chrome to wash away during acid cleaning.
- Cup and cone packing design to alleviate external leakage.
- Low pressure shutoff critical.

## Application expertise: Torqseal™ triple-offset valves

### Application

Black liquor vapor isolation

### Media

Black liquor, vapor with traces of black liquor.

### Problem

Soft seated high performance triple-offset valve gave tight shutoff, but for a short time. The migration of black liquor wore the seat causing vapor leakage.



### SOLUTION:

**Velan's Torqseal™ triple-offset metal-seated valve**

- Bubble tight with metal seat.
- Seat doesn't abrade/wear under harsh applications.
- Long-term solution—no maintenance required on metal seat.

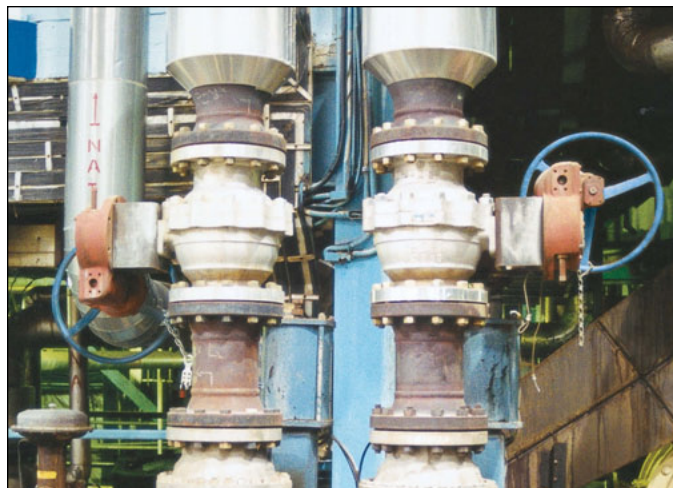

*Two 8" (200 mm) Velan Securaseal® metal-seated liquor isolation valves.*

# The pulping process

There are three ways to convert wood into fiber. The first is **mechanical pulping** or ground wood, the second is **sulfite pulping**, and the third is **kraft or sulfate pulping**.

**Mechanical pulping** is where logs are ground up in grinders or refiners. There are three types of **mechanical pulping**: PGW (pressurized ground wood); TMP (thermo-mechanical pulping), where the logs are pre-steamed; and TCMP (thermo-chemical-mechanical pulping), where the logs are pre-steamed with chemical treatment.

**Sulfite pulping** is where sulfurous acid softens wood fibers and dissolves lignin. The popularity of sulfite pulping is waning because the sulfurous acid discolors paper by burning the fibers, the corrosion is more severe, and chemicals can't be recovered.

**Kraft pulping** or sulfate pulping is the most common pulping technique and has three major cooking technologies: **continuous, batch, and enhanced cooking**.

## Continuous cooking

In **continuous cooking**, the continuous digester uses a heated, pressurized chamber into which chips and chemicals are fed.

This type of digester differs from the batch type in that the chips are processed in a downward flow through zones of steadily increasing temperatures and pressures until the cooking zone is reached.

Cooking liquor is continually circulated from the digester to heat exchangers, where the liquor is reheated and reinjected into the digester. The pH of the cooking liquors is 13.5 to 14 and the operating temperatures are 240°F at 140 psi.

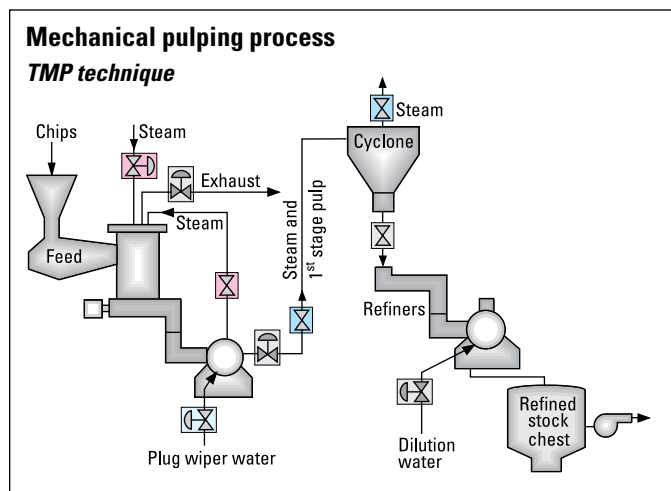

## Kraft pulping process

### Continuous cooking technique

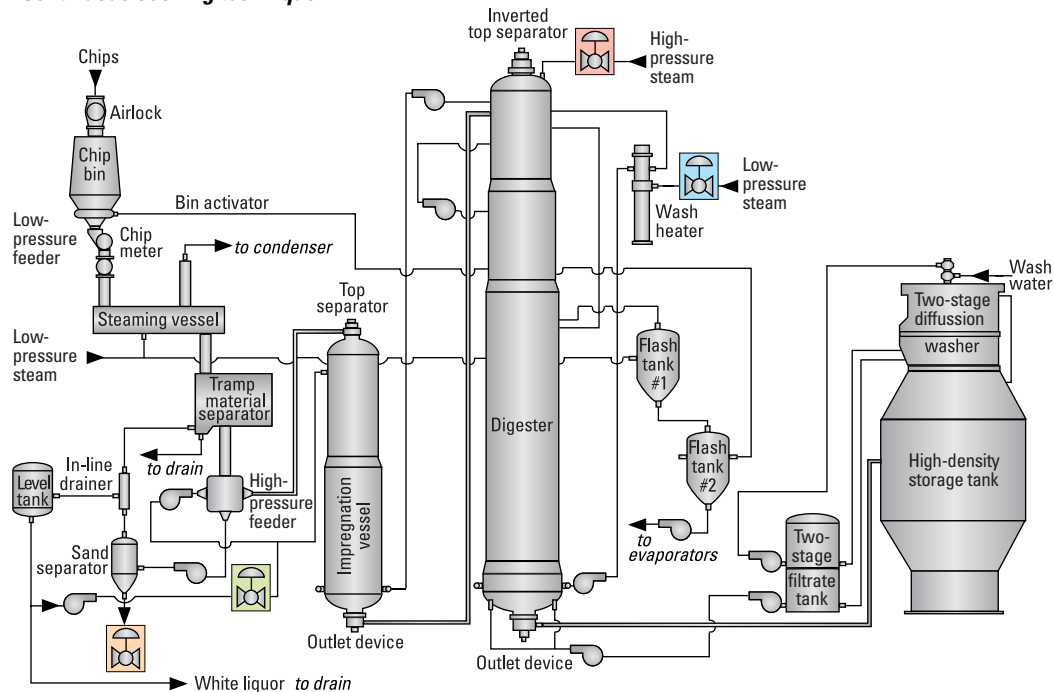

The high-pressure feeder (the heart of the digester) sends the chips to the digester inlet. A rotating helical screw pushes down chips through impregnation zones, where steam and liquor are injected into the zones to cook the chips. The chips remain in this area from two to three hours and the mass is cooled, mixed with black liquor, and mechanically conveyed or "blown" to the blow tank.

## Batch cooking

In **batch cooking** the digester is filled with chips, white cooking liquor, and steam to soften the wood chips. The chips are cooked for about three hours in this caustic atmosphere. The cooking liquor absorbs the impurities and it becomes black liquor. This cooking action destroys the bond between the cellulose fibers and the glue-like material called lignin that cements the fibers together.

After cooking, the pulp is blown into a blow tank where the shock of the material hitting the tank wall separates the softened lignin and fibers.

MEDIA	VALVE TYPE <sup>(1)</sup>	MEDIA	VALVE TYPE <sup>(1)</sup>
Level tank control	Securaseal®	High-pressure steam	Securaseal®
Sand separator	Securaseal®	Condensate	Securaseal®
Black liquor switching	Torqseal™	Low-pressure steam	Securaseal®
White liquor	Securaseal®	Water	Memoryseal™
Heater isolation	Securaseal®		
Blow flow control	Securaseal®		

(1) Consult Velan Sales Department for preferred valve

(1) For more information about other Velan valves suitable for the above media contact Velan.

## Enhanced cooking

The next generation of batch cooking is **enhanced batch cooking** where, once the cooking temperature is reached, spent cooking liquor is drawn through screens and is circulated with a pump to a heat exchanger. This liquor is displaced with brown stock wash filtrate.

The spent liquor is used to heat the next batch of liquor or filtrate. This type of digester is either blown with compressed air or pumped out.

The major benefit is the greatly reduced steam consumption over a standard batch digester.

## Brown stock washing

The next step in the pulping process involves **brown stock washers**, where the brown stock goes through a number of processes.

The first step is **defibering**, where fibers are mechanically separated.

Next is **deknottng**, where knots, rejects, or uncooked pulp are taken out of the process. This is accomplished with vibrating screens or pressure screens.

Another step in this process is **brown stock washing**. This is where the residual liquor is removed along with any contaminants in the pulp, which is then sent to the evaporators to recover the maximum amount of reusable chemicals. Brown stock washing is accomplished

by the use of diffusion, pressure, and belt washers.

Finally the pulp is screened, cleaned, and thickened and then sent to high-density storage tanks from where it can be sent to the bleach plant or to the paper machines.

## Kraft pulping process

### Enhanced cooking technique

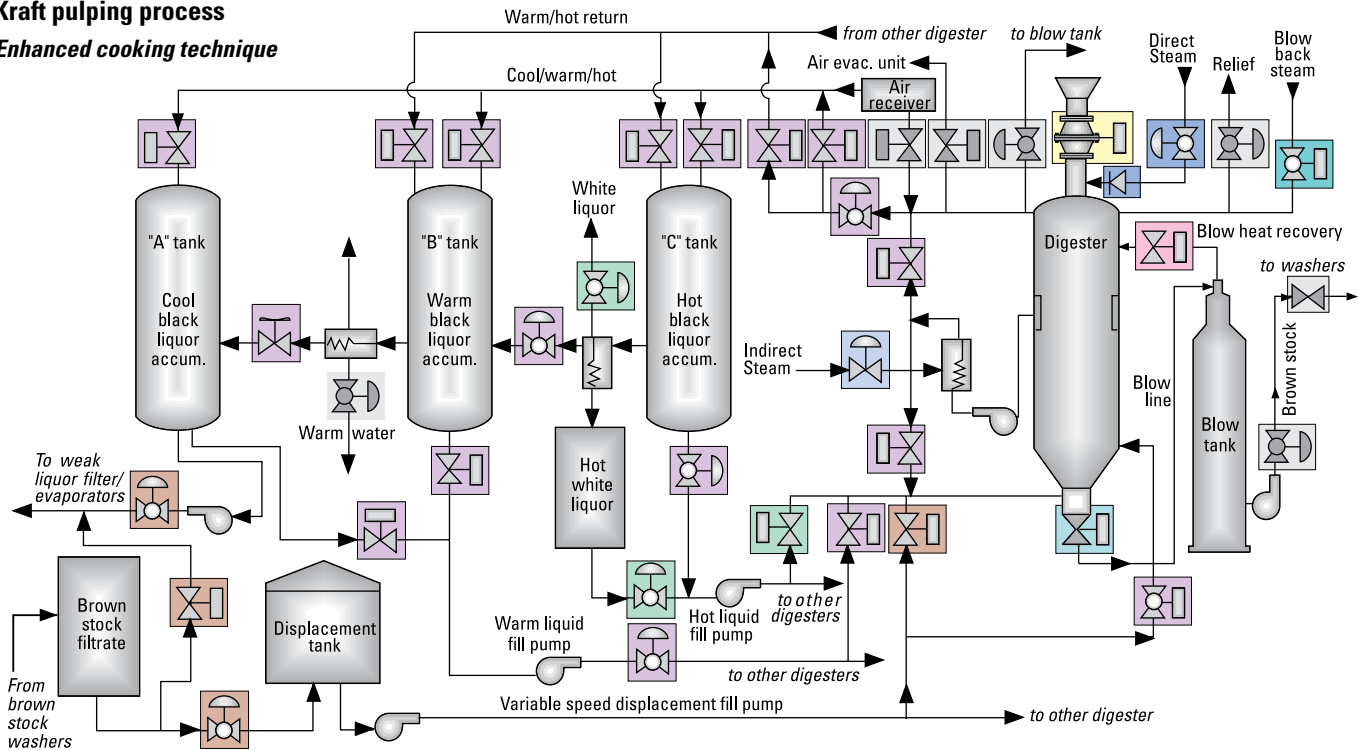

MEDIA	VALVE TYPE <sup>(1)</sup>
Flash steam	Securaseal®
Digester relief	Securaseal®
Direct steaming	Torqseal™
	Check valve
Indirect steaming	Torqseal™
Condensate	Memoryseal™
Blow line diversion	Securaseal®
White liquor	Securaseal®
Black liquor	Securaseal®

MEDIA	VALVE TYPE <sup>(1)</sup>
Capping valve	Cap-Tight™
Blow valve	Securaseal®
Blow back	Securaseal®
Gas off	Securaseal®
Brown stock filtrate	Torqseal™
Blow heat recovery	Knife gate (BBKGV)
	Consult Velan Sales Department for preferred valve

(1) For more information about other Velan valves suitable for the above media contact Velan.

## Brown stock washing process

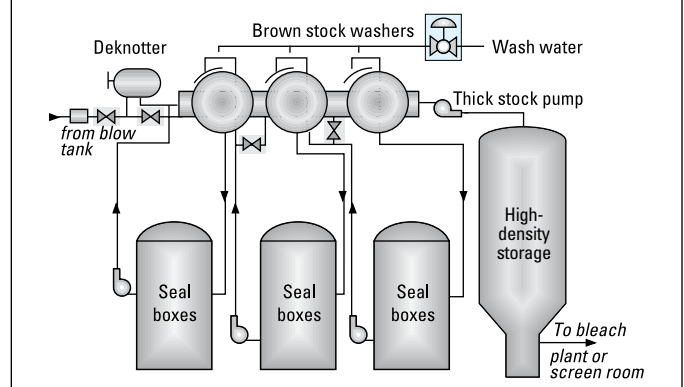



# The recovery process

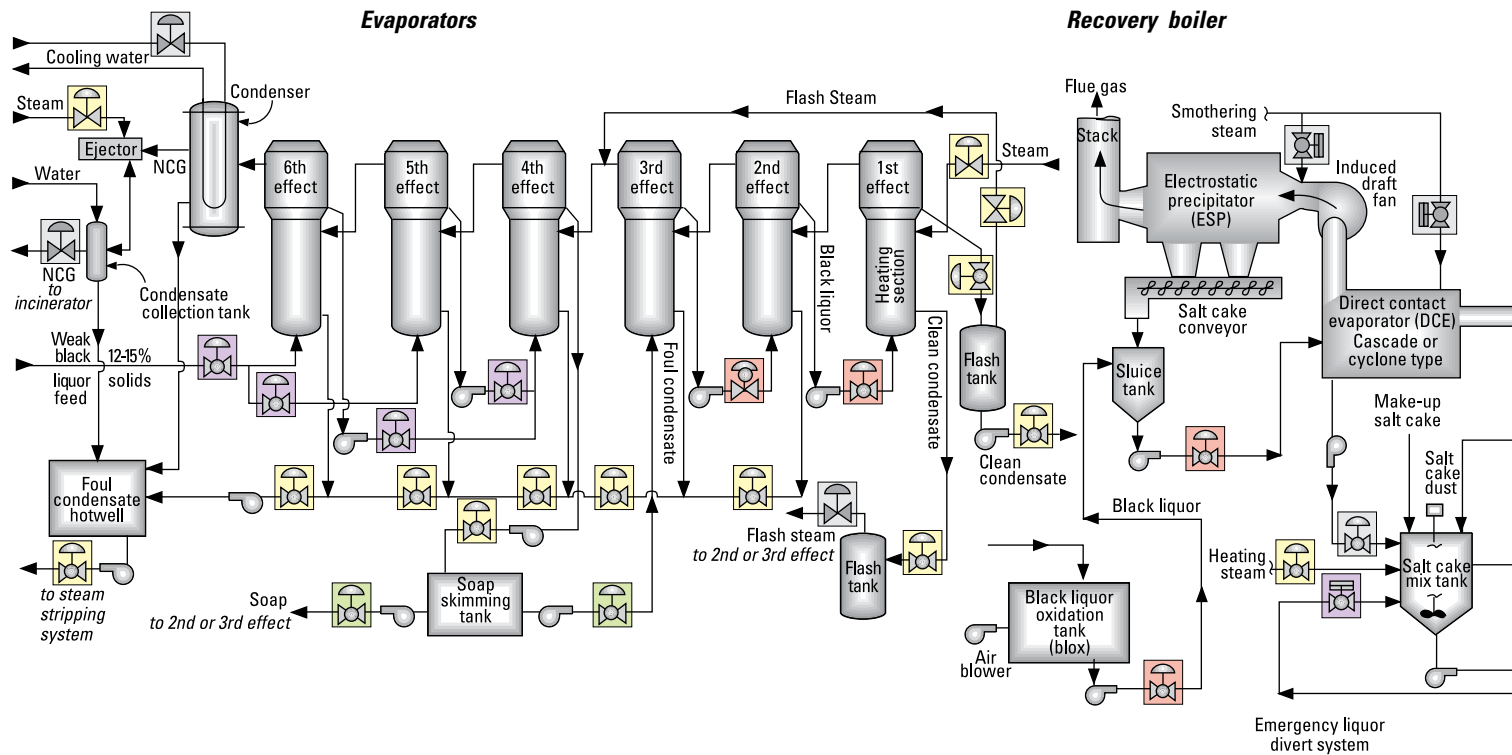

Recovery of usable chemical is critical in kraft cooking. The recovery area is a loop that takes the wash from the brown stock washers, evaporates the water out, burns the lignin (high BTU factor), and recovers the chemicals used in the cooking process.

## Evaporators

After the blow tank, the stock is washed in the brown stock washer. The fibers are transferred to the stock prep area and

the wash is recovered and sent to the evaporators. Evaporators take the water out of the liquor to create high-density black liquor to burn in the recovery boiler.

The evaporator island may include as many as six effects, where the vapor in one effect becomes the steam supply in the next unit. There are four types of evaporators: rising film, falling film, cascade, and cyclone.

## Evaporators

### MEDIA

MEDIA	VALVE TYPE <sup>(1)</sup>
Black liquor – < 50%	Bonneted knife gate
Black liquor – > 50% High density	Securaseal <sup>®</sup>
Soap	Memoryseal <sup>™</sup>
Tall oil	Memoryseal <sup>™</sup>
Steam – HP <sup>(2)</sup> > 150 psi/10.3 bar	Torqseal <sup>™</sup>
Steam – LP <sup>(3)</sup> < 150 psi/10.3 bar	Memoryseal <sup>™</sup>
Condensate	Memoryseal <sup>™</sup>
Water	Knife gate
Filtrate	Knife gate
Weakwash	Knife gate

<sup>(1)</sup> Consult Velan Sales Department for preferred valve.

<sup>(2)</sup> For more information about other Velan valves suitable for the above media contact Velan. <sup>(3)</sup> High pressure steam. <sup>(3)</sup> Low pressure steam.

## Recovery boiler

Heavy black liquor is pumped to a black liquor storage tank at the recovery boiler where it is mixed with salt cake (sodium sulphate), as a make-up chemical to replace the chemicals lost during washing and evaporation. The black liquor is pumped into the boiler through nozzles, where the black liquor is vaporized and burned.

The organics in the liquor burn as fuel, while the chemicals fall to the bottom of the boiler and flow out as smelt. The smelt flows into a dissolving tank filled with weak wash liquor from the causticizing area. The smelt is agitated and recycled to break up the molten smelt and prevent an explosion. The liquor in the dissolving tank is called green liquor.



Velan metal-seated ball valves on a new evaporation installation.



## Causticizing area

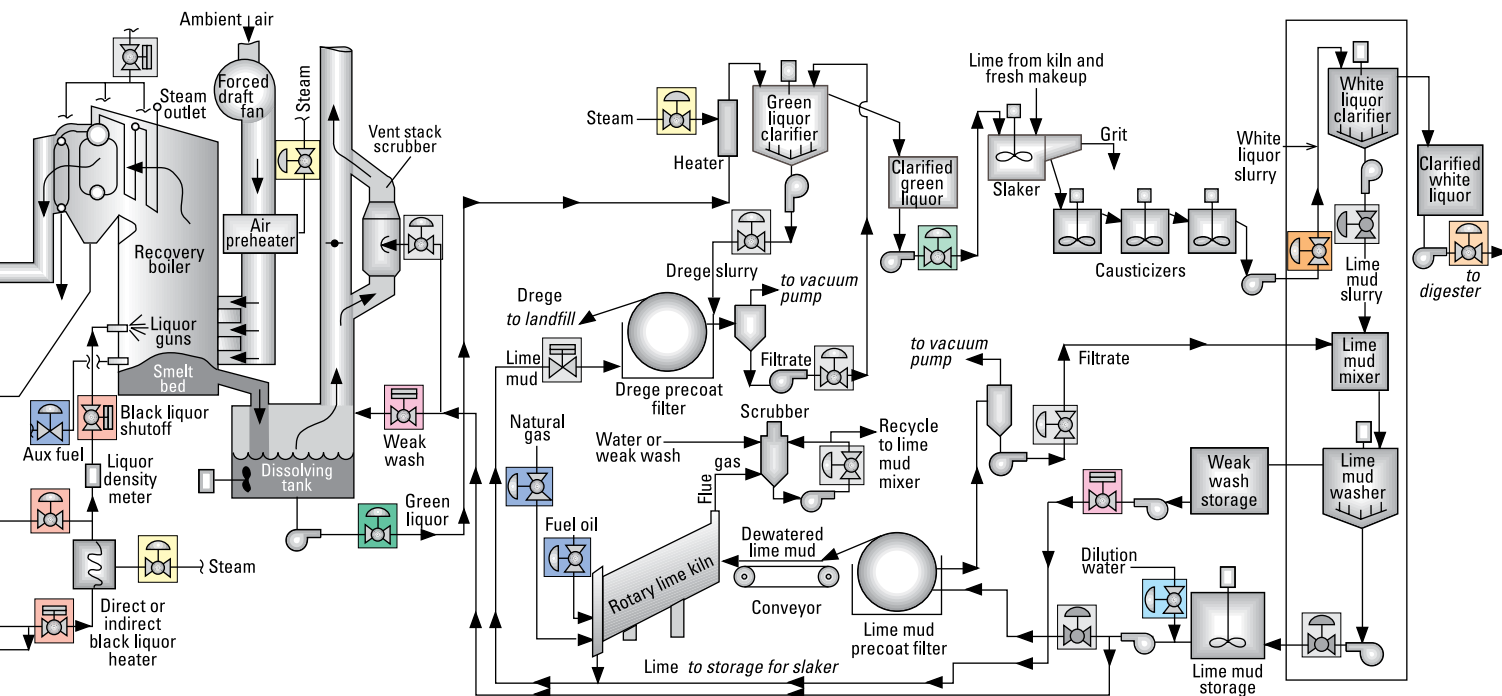

### Recovery boiler

MEDIA	1ST CHOICE
Feed water	Pressure seal
Steam – HP	Pressure seal
Drains	Power ball
Soot blower steam	Power ball
Aux. fuel (NG)	Memoryseal™
Aux. fuel (Oil)	Memoryseal™
Flue gas	Torqseal™

Consult Velan Sales Department for preferred valve.

### Causticizing

Green liquor from the dissolving tank is pumped to the causticizing area where it is treated with milk of lime (calcium hydroxide), to form white liquor.

As green liquor contains impurities called dregs, it first must be filtered in a clarifier. The clarified green liquor is pumped to the slaker where it is mixed with burnt lime (calcium oxide).

The lime-green liquor mixture flows to two or three causticizers in a series to complete the reaction. The liquor is separated from the lime mud and becomes white liquor.

The calcium carbonate precipitate is burned in the lime kiln to form calcium oxide for use in the causticizing area.

### Causticizing

MEDIA	VALVE TYPE <sup>(1)</sup>
White liquor – clarified	Torqseal™
White liquor – unclarified	Securaseal®
Green liquor – clarified	Securaseal®
Green liquor – unclarified	Securaseal®
Weak wash	Knife gate
Dilution water	Knife gate
Weakwash	Knife gate
Natural gas	Memoryseal™
Fuel oil	Memoryseal™
Steam	Torqseal™

Consult Velan Sales Department for preferred valve.

(1) For more information about other Velan valves suitable for the above media contact Velan.



Velan's bolted bonnet knife gate eliminates packing leaks on chemical laden fluids.

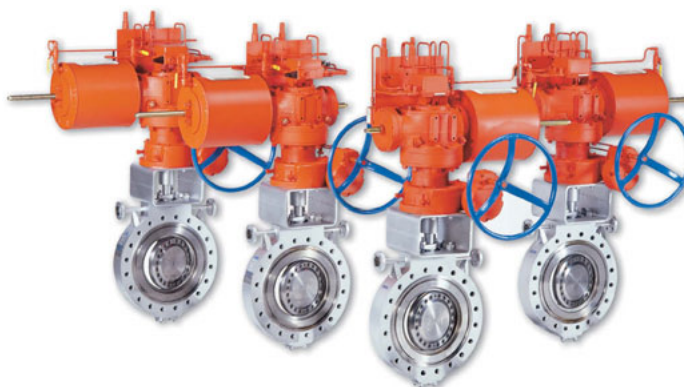

Velan's Torqseal™ triple-off-set valve has had great success in recausticizing.

# The bleach plant and paper machine

## The paper processes

Once the stock is washed it goes either to the **bleach plant** or to the **stock prep area**. The bleach plant whitens the stock before it goes to the stock prep area. The stock prep area prepares the stock to go on the wire. The **paper machine** makes paper out of the stock.

## Bleach plant

Once the pulp is washed it goes to the bleach plant where the pulp is whitened to meet the stringent requirements of many customers.

The bleach plant is a chemical process that the pulp passes through. The bleaching process happens in sequences. Chlorination, hypochlorite, chlorine dioxide, peroxide, and oxygen are some of the sequences used in the bleaching process.

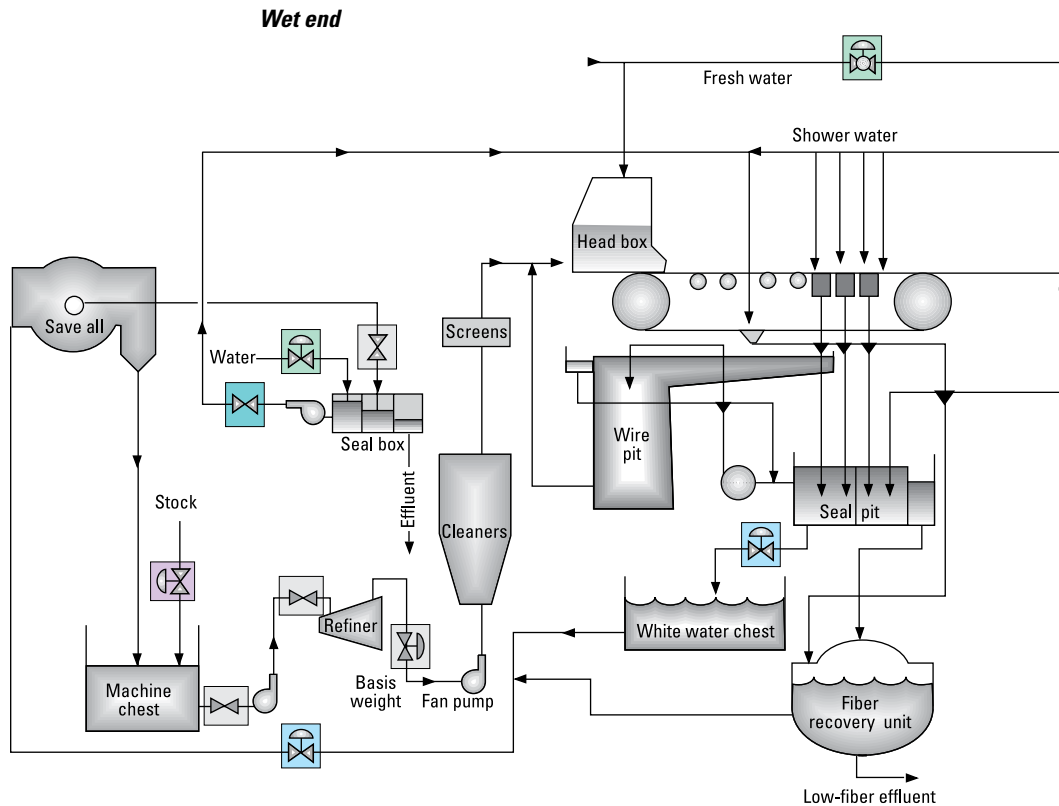

## Bleaching

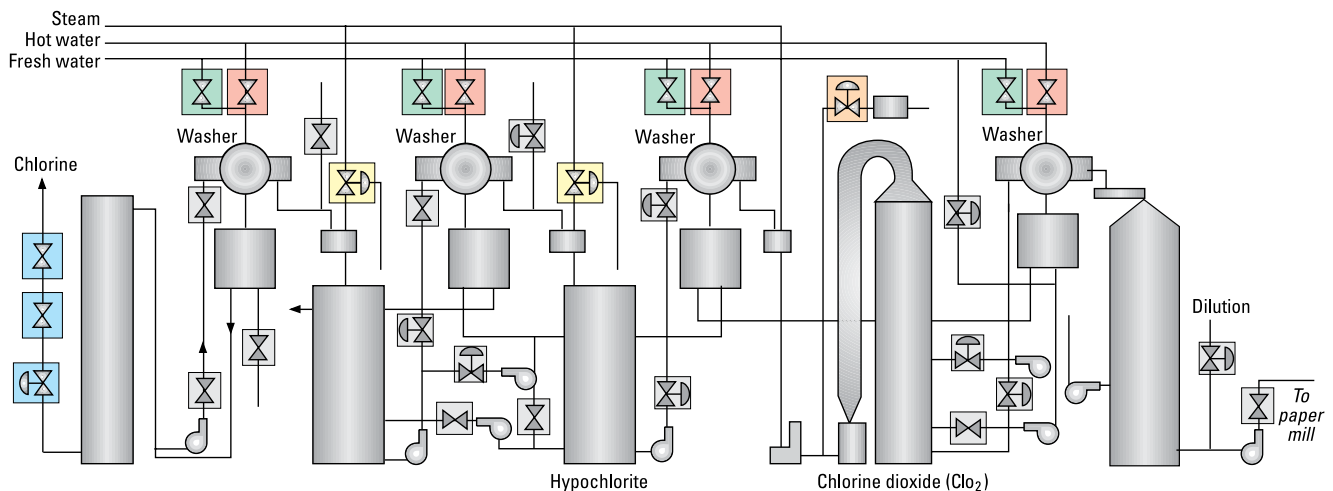

These sequences can be used more than once in the process. This is a highly corrosive area of a mill.

MEDIA	VALVE TYPE <sup>(1)</sup>
Steam	Memoryseal™
Hot water	Memoryseal™
Fresh water	Memoryseal™
Chlorine	Memoryseal™ High alloy

MEDIA	VALVE TYPE <sup>(1)</sup>
Chlorine dioxide	Memoryseal™ High alloy
Oxygen	Memoryseal™
Hypochlorite	Memoryseal™ High alloy
Hydrogen peroxide	Memoryseal™

■ Consult Velan Sales Department for preferred valve.

(1) For more information about other Velan valves suitable for the above media contact Velan.

## Dry end

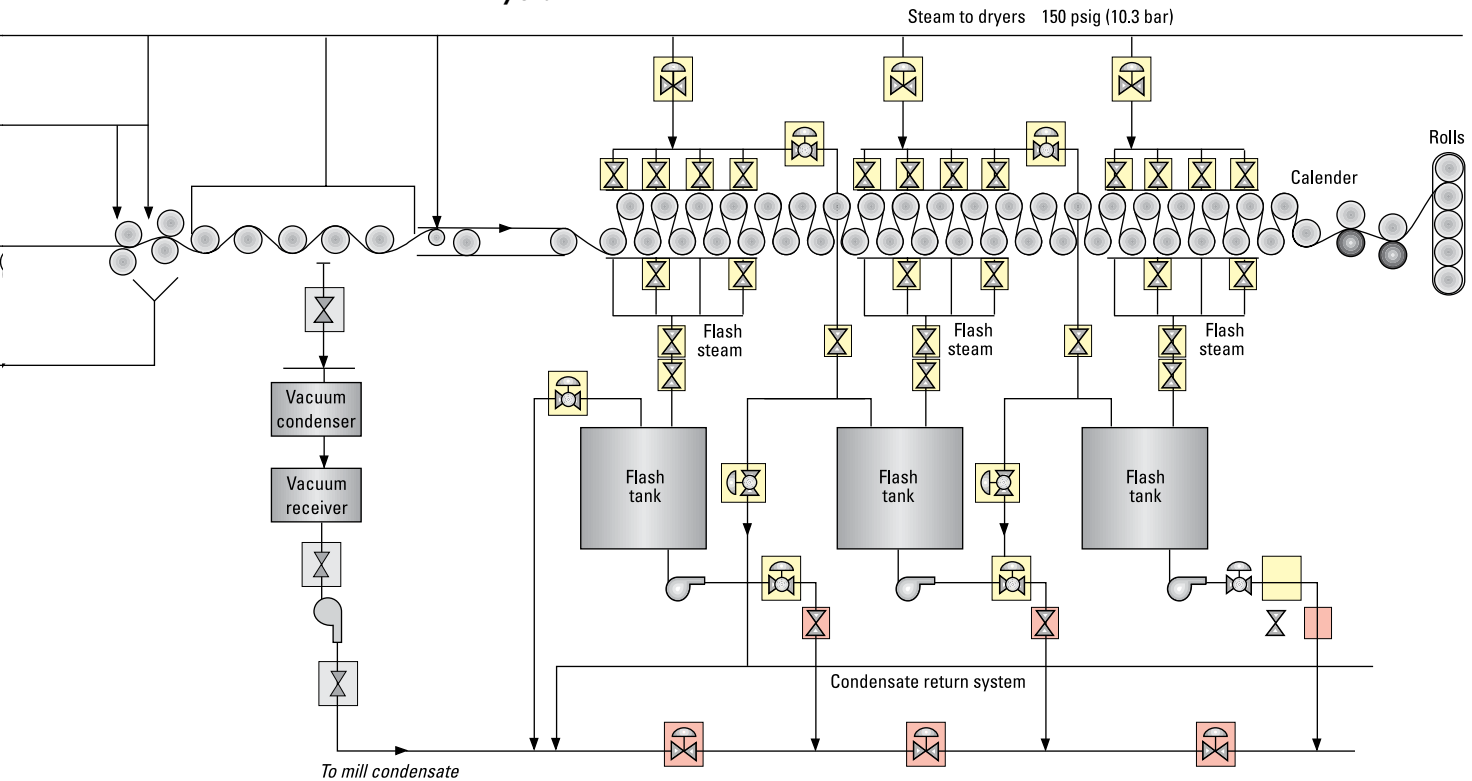

## Stock Prep

The objectives in stock preparation are to process the fibrous raw materials (pulp) and the non-fibrous components (additives) and combine them into a papermaking furnish. The steps used to do this are beating and refining, addition of additives, metering, and blending.

MEDIA	VALVE TYPE <sup>(1)</sup>
Stock	Knife gate
Refiners	Knife gate
Cleaners	Knife gate
Steam	Memoryseal™
Water	Memoryseal™
Condensate	Memoryseal™ or forged steel

Consult Velan Sales Department for preferred valve.

(1) For more information about other Velan valves suitable for the above media contact Velan.



Some of Velan's ball, globe, check, and gate valves, used in pulp and paper applications.

## Paper machine

The simplest way to explain a paper machine is that the pulp is put on a wire (Fourdrinier) and dried to form a sheet. The fact of the matter is the paper machine is very complex. The stock consistency basis weights are critical measurements in the paper machine process. The stock is sent to a headbox, which distributes the stock evenly on to a moving forming wire. The water drains from the fibers by gravity and is dewatered by suction. The sheet then goes through a series of presses where additional water is removed. The sheet then goes through a dryer section and the rest of the water is removed.

The sheet moves on to the calender section where the sheet is pressed between metal rolls to reduce thickness and is then finally put onto a roll for shipment.

MEDIA	VALVE TYPE <sup>(1)</sup>
White water	Knife gate
Steam	Memoryseal™
Vacuum	Memoryseal™
Shower water	Memoryseal™
Fresh water	Memoryseal™
Seal water	Memoryseal™
Condensate	Memoryseal™ or forged steel

Consult Velan Sales Department for preferred valve.

(1) For more information about other Velan valves suitable for the above media contact Velan.



The finished product—rolls of paper.



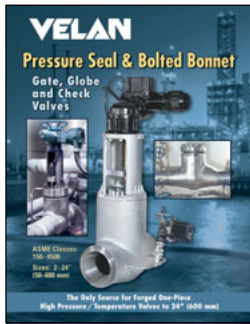

**VEL-PS**

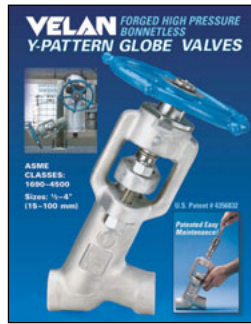

**VEL-BG**

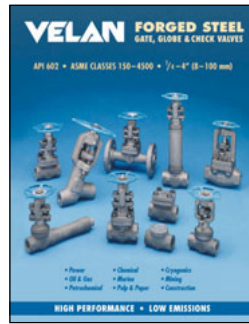

**VEL-SFV**

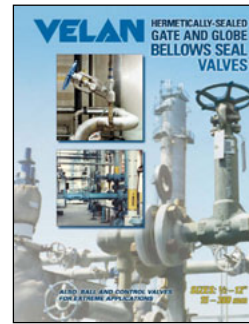

**VEL-BS**

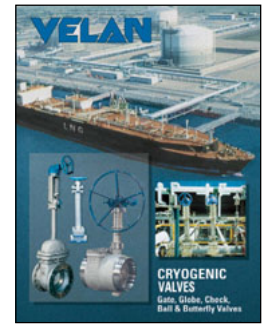

**VEL-CRYO**

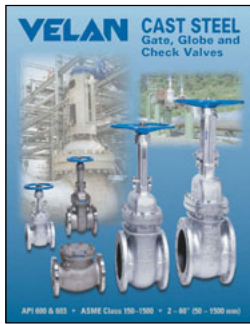

**VEL-CSV**

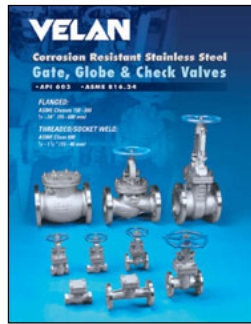

**VEL-API-603**

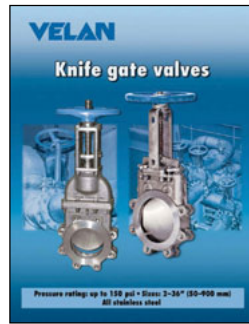

**VEL-KGV**

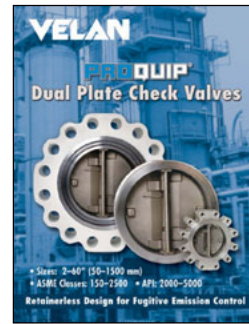

**VEL-POCV**

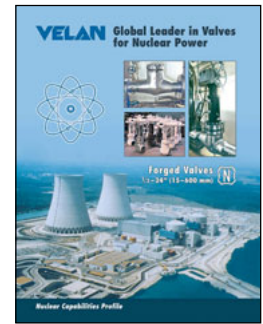

**VEL-NCP**

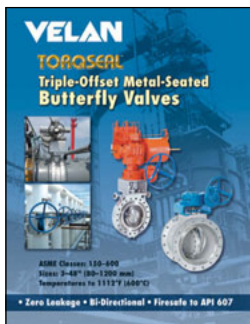

**VEL-BF**



**VEL-MS**

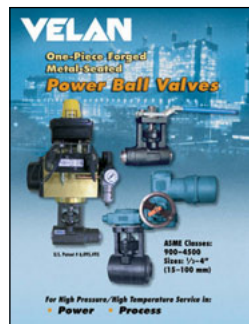

**VEL-PBV**

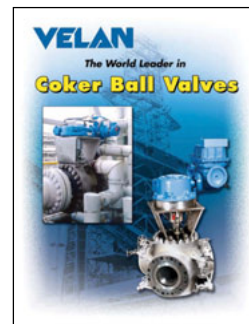

**VEL-CBV**

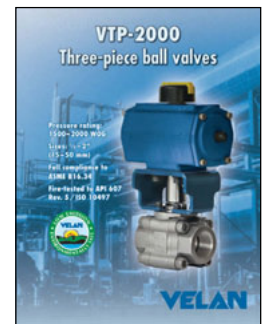

**VEL-VTP**

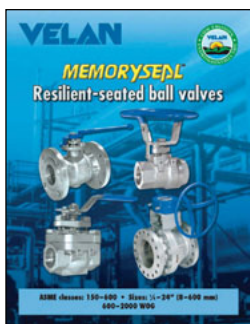

**VEL-BV**

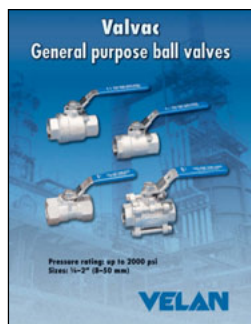

**CAT-GPBV**



**CAT-SAS-CFLEX**



**CAT-SAS-CCON**

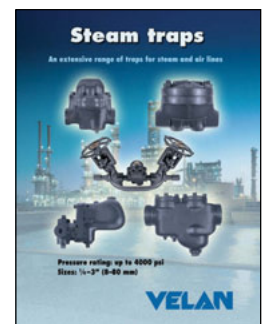

**CAT-VEL-ST**

Headquartered in Montreal, Canada, Velan has several international subsidiaries. For general inquiries:

**Velan head office**  
7007 Côte de Liesse,  
Montreal, QC H4T 1G2 Canada

Check our website for more specific contact information.

Tel: (514) 748-7743 Fax: (514) 748-8635

[www.velan.com](http://www.velan.com)

© 2010 Velan Inc., Montreal, QC, Canada. All rights reserved. The contents hereof are confidential and proprietary to Velan. Any unauthorized reproduction or disclosure, in whole or in part, is strictly prohibited. Velan reserves the right to change this information without notice. Velan Valves, Velan Inc., Memoryseal, Securaseal, Torqseal, Propquip, Velflex, Adaxie, and RAMA are trademarks or registered trademarks of Velan Inc. and/or another Velan company. Stellite® is a registered trademark of Deloro Stellite Group. All other trademarks and registered trademarks are owned by their respective companies.



**BRO-PP-03-10**  
Printed in Canada