

VELAN SECURASEAL[®]

Severe service valves for the mineral processing industry

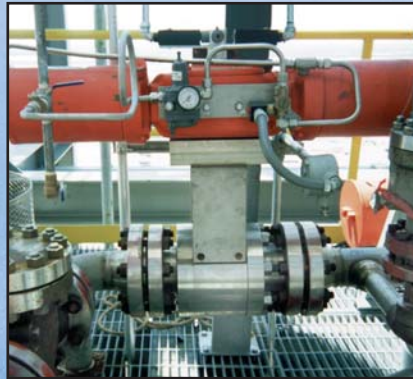

- *Process ore slurry isolation*
- *Oxygen feed lines and other process gases*
- *Water flush lines*
- *Vent gas lines*
- *Sample lines*
- *Slurry pump isolation*
- *Autoclave inlet & discharge*
- *Acid injection*
- *Steam sparge*
- *Copper/slag slurry*
- *Zinc tailing slurry*
- *HP slurry*
- *Tailing isolation*



A world leader in valve design, engineering solutions & manufacturing



Velan Securaseal severe service ball valves for mineral extraction in service.

Leading the way...

Velan is one of the world's largest manufacturers of industrial steel valves, internationally recognized as a leader in quality and innovation. Founded by A.K. Velan in 1950, the company leveraged advanced engineering capabilities and innovation-driven focus to continuously expand its offering of industrial valves. Today, Velan gate, globe, check, ball, butterfly, knife gate and engineered severe service valves are installed throughout the world, handling diverse applications in the petrochemical, pulp and paper, power, chemical, cryogenics, refining, oil and gas, mining, and marine industries.

Engineered solutions

Velan's Engineering Department has vast experience and sophisticated software and testing tools that enable the company to find solutions to any customer challenge.

Whether it is for valves to handle liquid Helium at -272°C (-458°F) in the world's largest particle accelerator at CERN, Geneva, four-way switch coker ball valves to handle one of the refining industry's toughest services, or valves for main steam isolation service in an operating nuclear power plant, Velan has been selected by most of the world's leading engineering construction firms and industrial end users. A long-standing commitment to quality has kept Velan at the forefront of industry standards.

Velan holds all major industry certifications, including ASME Section III, ISO 9001:2000, PED and API 6D. Many prominent companies have established partnerships or global supply agreements with Velan.

A global manufacturing leader

With over 1,000,000 sq. ft. (over 100,000 m²) of production space in twelve specialized manufacturing plants, including five in Canada and U.S.A., four in Europe and three in Asia, Velan is a truly global manufacturing force.

Velan uses the latest automation technology; including over 175 CNC machines and many special purpose transfer machines, enhanced with proprietary production techniques. A wide variety of equipment provides the company with the ability to efficiently handle highly customized orders, as well as large production runs.

Velan employs 1,500 people, 75% of which are located in North America. International production centers are complemented by a global sales and distribution network, offering personal customer service and quick access to stock worldwide. Because customer requirements for immediate deliveries

have escalated in the last few years, Velan has opened three quick-ship warehouses in North America to supplement the inventories of our stocking distributors.

Total quality commitment

Velan is totally committed to offering products and service that not only meet, but exceed customer expectations. All Velan valves are designed and manufactured with an emphasis on low emissions, safety, simple maintenance, ease of operation, and above all, long and reliable service life. In fact, when a leading Houston repair shop recently did an analysis on the reliability and repairability of commodity valves, Velan finished first. Whether we are manufacturing commodity valves or specialty valves, our objective is to deliver excellent long term value to our customers.

Visit the Velan website at www.velan.com

TOTAL QUALITY COMMITMENT

Our aim is to offer products and services, which not only meet, but also clearly exceed, the expectations of our customers.

Through training, teamwork and performance, our employees strive to achieve continuous improvement of all processes.

Our goal is Total Quality and On-Time Delivery; our method is Total Commitment.

A.K Velan

Severe service valves for mineral processing

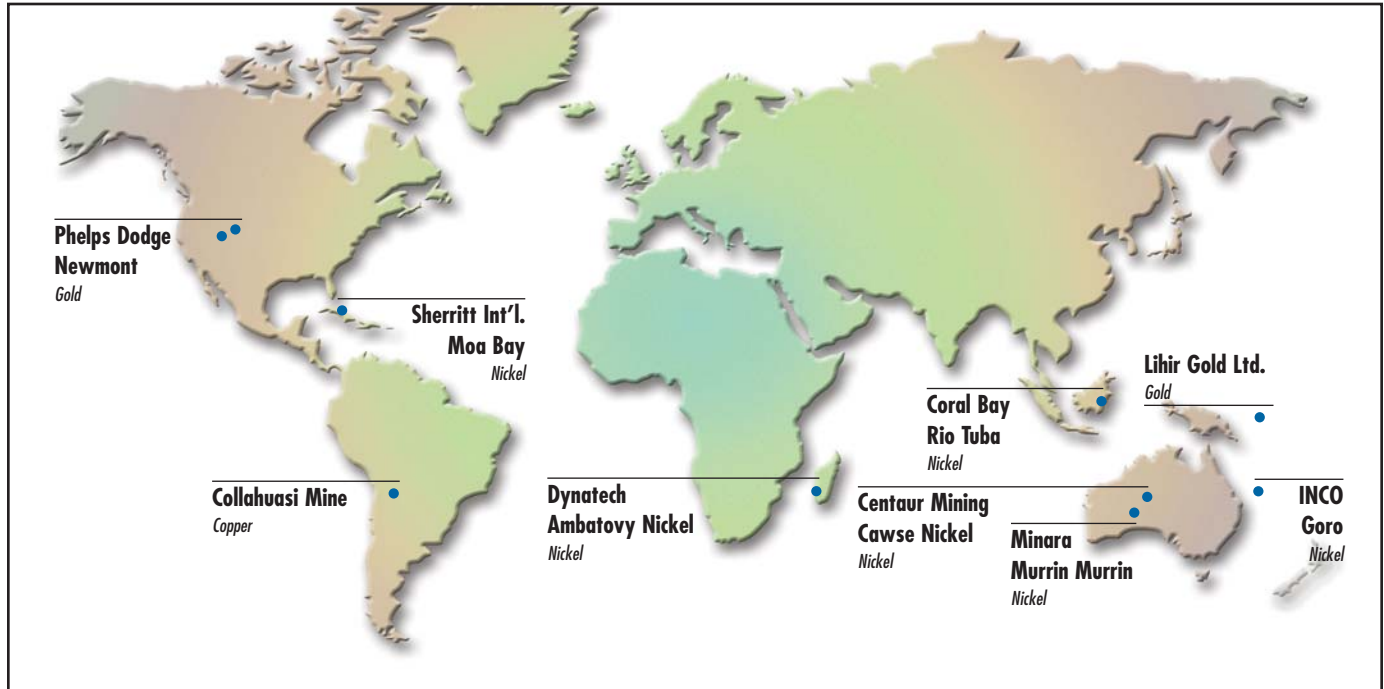

Locations worldwide using Velan Secura seal severe service ball valves for mineral processing.

Severe service metal-seated ball valves in HPAL autodave applications

Since the introduction of the HPAL process in gold and nickel extraction, Velan Inc. has worked extensively with valves installed in almost every HPAL location worldwide. Our extensive supply and in-service experience, engineering resources, back up service and support has been proven and is critical to the successful operation in HPAL applications.

HPAL expertise and experience

Velan has more HPAL experience than all other severe service ball valve suppliers combined. Velan's experience dates back to the early 1990's with the Moa Nickel Project in Cuba and the Nevada Gold projects. Both Porgera and Lihir gold operations in PNG followed in the mid 90's.

The largest HPAL plant commissioned to date is the Murrin Murrin Nickel-Cobalt Plant in Western Australia. Velan was the

sole supplier of severe service ball valves to this project and we have supplied in excess of 1000 valves to the project since 1997.

Velan in cooperation with our local representatives have successfully managed the Murrin Murrin Severe Service ball valve population since 1998. Together, we have developed several design and material enhancements which are incorporated in our current design. Velan continues to be the preferred supplier of Severe Service metal-seated ball valves for the PAL circuit at Murrin Murrin.

During 2003/04 we supplied valves in Titanium, Duplex SS and Alloy 20 to Coral Bay Nickel Corporation's (CBNC), Rio Tuba Nickel Project in the Philippines. The Rio Tuba PAL plant was commissioned in August 2004 and our valves have completed almost two years in service at the latest Nickel PAL plant built in the world.

Velan's HPAL product line

Severe service metal-seated process valves

Regular or full port, 1/2-24" (15-600 mm)
Type R split-body, SB-900/1500/2500/4500
ASME Classes 900-4500
Type N ASME Classes 150-4500



Torque seal triple-offset butterfly valves

Flanged, wafer & lug types, 3-48" (80-1200 mm)
Zero-leakage, Bi-directional & firesafe to API 607
ASME Classes 150-600



Gate, globe, check and ball valves

Regular or full port, 1/2-60" (15-1500 mm)
API 602, cast steel, dual plate check and memory seal ball valves
ASME Classes 150-4500



In late 2005 Velan was awarded the supply contract for the Severe Service Valves on the Goro Project in New

Caledonia. Construction is Titanium and Duplex with the largest size 14", a first for HPAL application.

**½ – 24" (15 – 600 mm), regular or full port
flanged, butt weld, socket weld, threaded and clamp style ends
ASME Classes 150, 300, 600, 900, 1500, 2500, 4500**

Tight shutoff to ASME/FCI 70-2 Class VI, MSS-SP61 or API 598

The Securaseal Type N was designed and developed for the most severe services heavy industry has to offer. None are more severe than high

pressure leaching by acid or oxygen used in the refining of nickel and gold ores. These services push every piece of equipment to the absolute limit

requiring not only a sound and very robust design but also one that is on the cutting edge of technology.

Downstream seat
Up To 6" (150 mm)

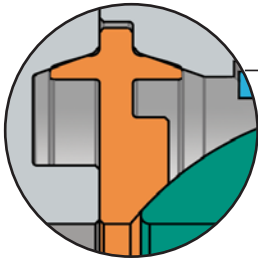

Fixed primary sealing seat

prevents slurry ingress behind the sealing seat.

Velan's exclusive "integral body seal/seat" design for valves up to 6" is 100% effective in eliminating slurry ingress behind the primary sealing seat.

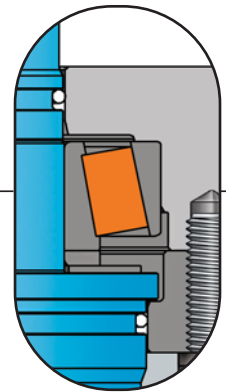
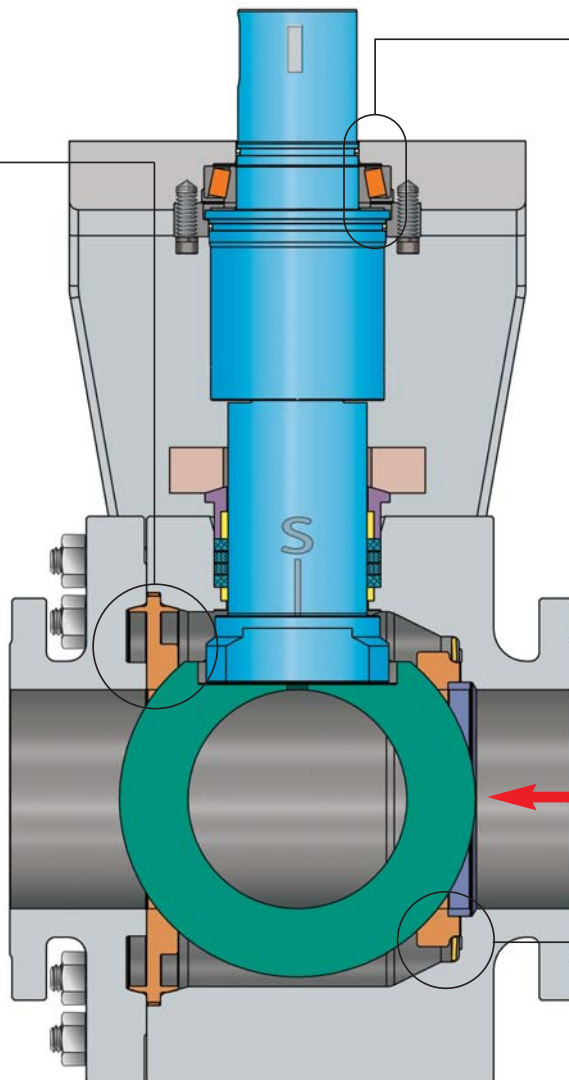

External stem thrust bearing

reduces valve torque by 50-80%, a significant benefit in slurry services that are prone to scale build up.

In competing designs the thrust washer within the valve cavity, which can deteriorate over time due to the corrosive and scaling attributes of this service.

Arrow indicates the primary sealing direction.

A fully bidirectional design is also available.

½ – 6" Type N design

for the toughest mining applications

Heavy duty design with maximum safety factors

Large stem safety factors ensure the valve will operate (cycle) when required.
 Stem sizing allows for the seat spring force to be increased in order to withstand large reverse pressures without requiring a stem design change.

Stem and thrust washer

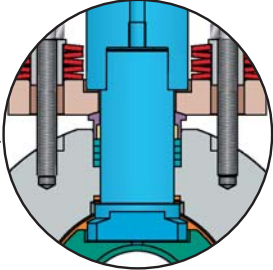

Fully guided stem with live-loaded packing flange and improved stem seal design.
 Fully guided by the upper and lower stem bushings.

Downstream seat

8" (200 mm) and up

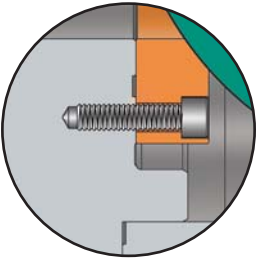

Bolted primary sealing seat

prevents slurry ingress behind the sealing seat.

For valves 8" and over, we offer a bolted-in seat that provides the same level of protection against slurry ingress as our Integral design.

Upstream seats

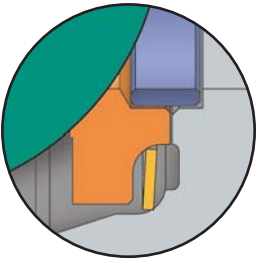

Precision machined load ring

energised during assembly.
 Not prone to premature fatigue.
 Maintains tight contact between ball/seat and seat/body regardless of installation orientation.
 Seat design applies to all sizes.

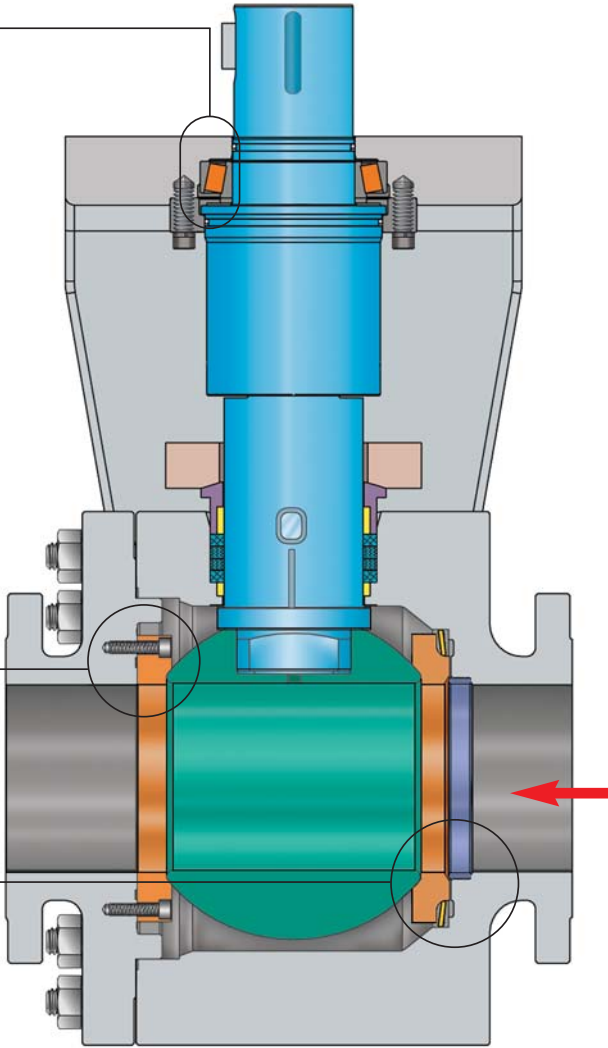

8" & up Type R design

Velan's advanced coating technology

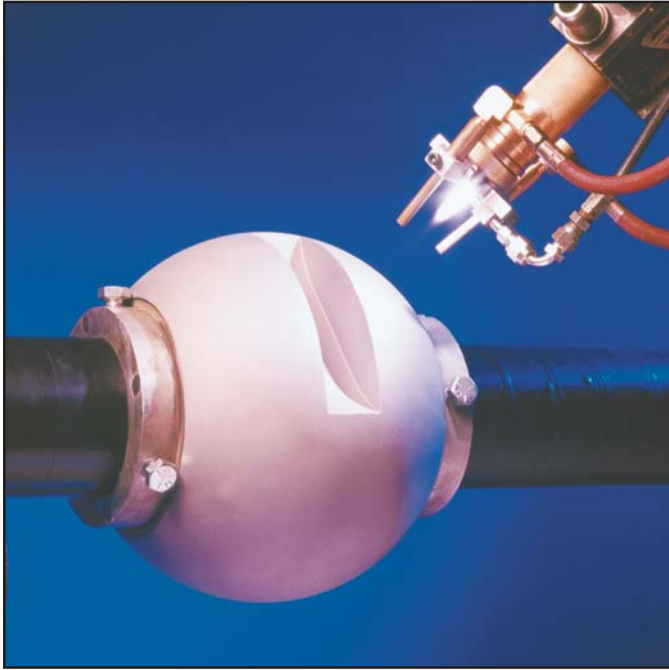

Advanced ceramic coatings technology.

Advanced ceramic coatings

Velan is engaged in advanced research in metal spray technology, using the services of independent laboratories for abrasion, sliding wear, bond strength testing, scanning electron microscopy and x-ray diffraction.

Securaseal Valves using Velan's latest coating, a proprietary blend of Titania and Chromia with a Tantalum bond coat, have exceeded 12 months in service and over 200 cycles with zero corrosion and little to no wear being evident on the valves that were inspected.



Ball with ceramic coating in half open position, after several months in service.

Thermal spray technology

Type	Chrome oxide	Titanium oxide	Titania chromia
Hardness	68–70 R _c	60 R _c	> 60 R _c
Adhesion	> 7,000 psi	> 8,000 psi	> 9,000 psi
Top coat porosity	< 3%	< 3%	< 3%
Bond coat porosity	N/A	N/A	< 1%
Applications	HPOX slurry inlet/discharge Oxygen sparge Steam gas vent	HPAL slurry inlet/discharge Slurry pump isolation Steam/gas vent lines	HPAL slurry inlet/discharge Slurry pump isolation Steam/gas vent lines

Engineering capabilities and automation solutions



Securaseal severe service ball valve with pneumatic actuator.

Automation services

Velan offers a wide range of automation alternatives to meet each customer application including electrohydraulic, pneumatic and hydraulic actuators.

Our philosophy is to offer what the customer wants and make sure the complete package is of the highest quality.

Automation service capabilities include:

- Electrohydraulic, pneumatic and hydraulic actuators
- Preinstallation of switches, positioners, thrust and torque sensors, signal conditioners
- O.E.M. actuators through Velan stocking distribution or actuators of the customer's choice
- Overrides, limit stops and most accessories standard

Engineering capabilities

Combining almost 20 years of experience in critical applications in the mineral processing industry, Velan has brought together a team of over 50 professional engineers who form the core of the Engineering Design Group. Advanced software applications, including Finite Element Analysis (FEA), computational fluid dynamics and three-dimensional solid modeling, help Velan design superior quality valves that meet the most demanding performance requirements.

We have two R&D facilities, with steam boilers and superheaters, flow loops and cryogenic test stands.

Velan has a longstanding history of partnering with major Architect/ Engineers and end users to develop innovative solutions for their valving needs. Velan valves are built to last, often having gone decades with minimal maintenance performed.

Specific engineering capabilities include:

- Valve design
- Stress analysis and finite element analysis
- Application engineering
- Flow analysis
- Thrust and torque calculation
- Actuator sizing
- Root - cause failure analysis
- Weak link analysis
- System upgrades
- Risk analysis
- Custom testing and test data analysis (NDT, X-ray review, UT testing, etc.)
- Validation of retrofit changes

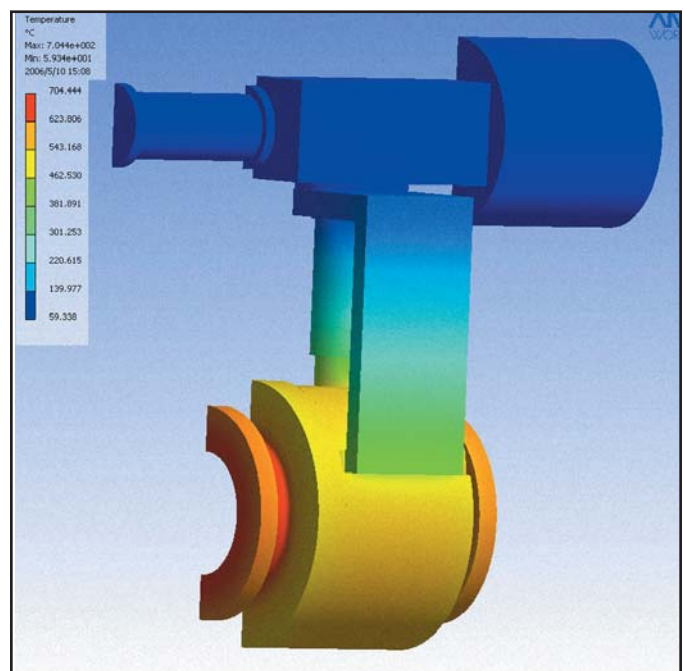

An actuated Securaseal metal-seated valve undergoing heat transfer analysis.

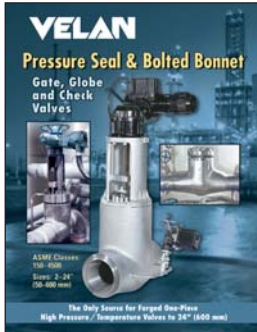

VEL-PS

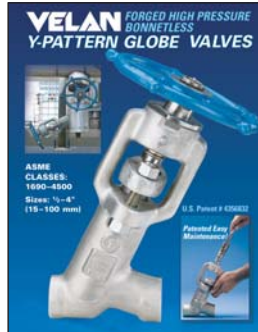

VEL-BG

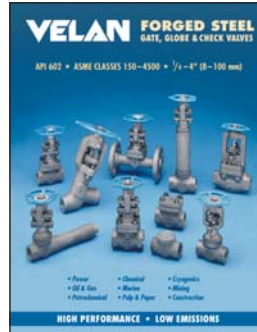

VEL-SFV

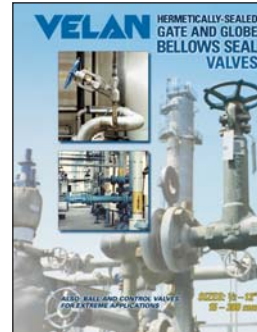

VEL-BS

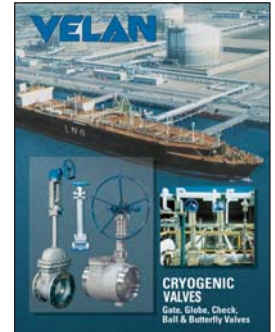

VEL-CRYO

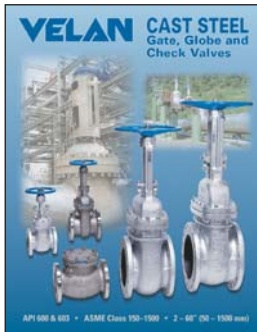

VEL-CSV

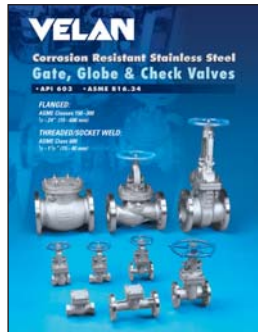

VEL-API-603

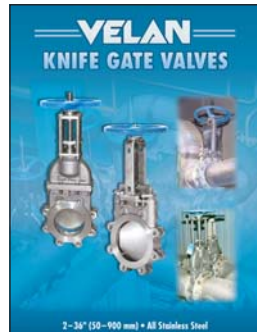

VEL-KGV

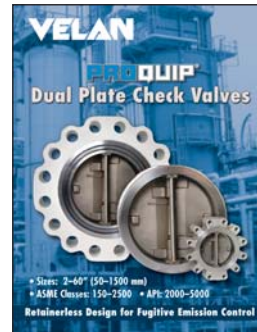

VEL-PQCV

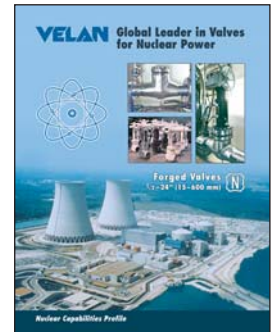

VEL-NCP

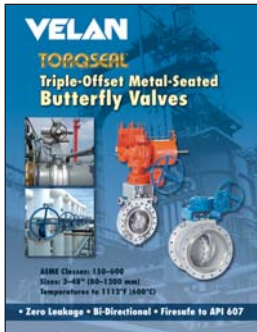

VEL-BF



VEL-MS

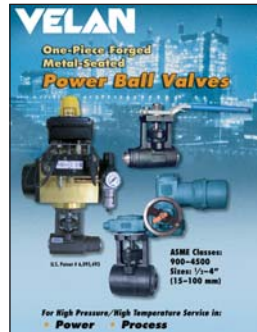

VEL-PBV

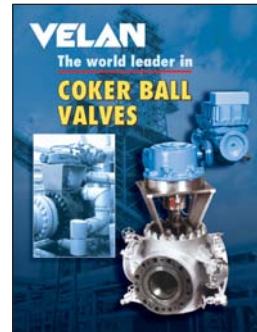

VEL-CBV

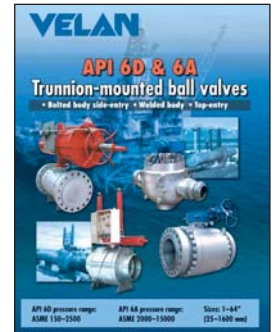

VEL-BV6D



VEL-BV

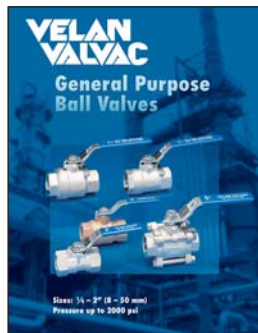

VEL-GP2BV

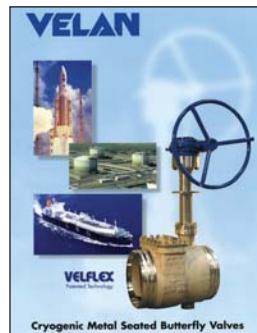

VEL-SAS-BF

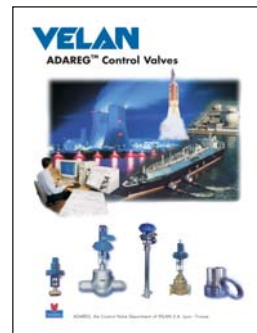

VEL-ADCV

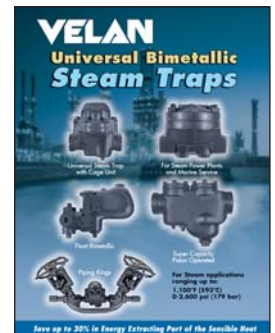

VEL-ST